

Za tehnično podporo ali pomoč pokličite  
**090-6009**



## Zebra DS3600 Quick Start Guide

Več informacij: <http://bit.ly/citalec3608>

---

Vprašanja? Kontaktirajte naše strokovnjake



090-6009



servis@info-kod.si



<http://www.info-kod.si>

Ponedeljek – Petek od 9:00 do 15:00

<http://www.zebra.com/3600series>

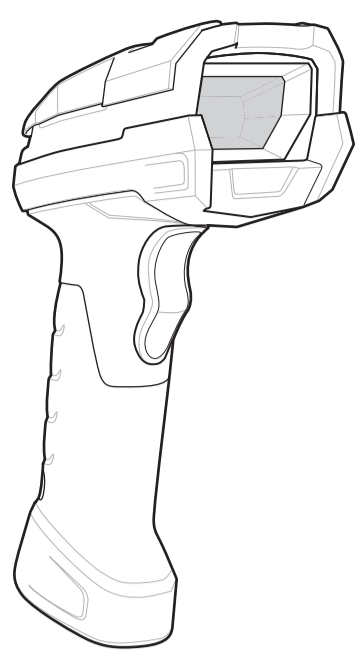

**Digital Scanner**  
**Quick Start Guide**

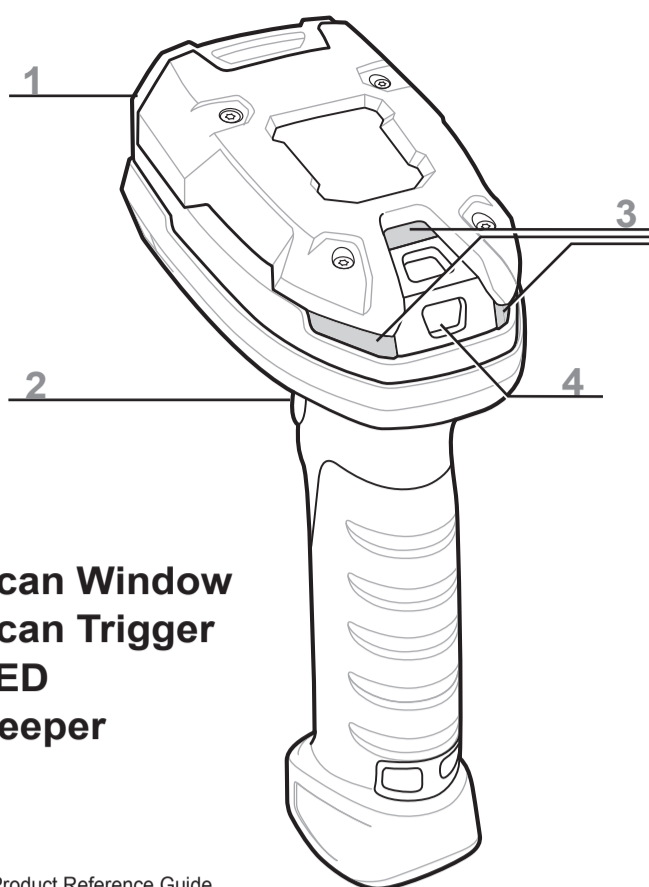

- 1 Scan Window
- 2 Scan Trigger
- 3 LED
- 4 Beeper

See Product Reference Guide for detailed information

**Intellistand**

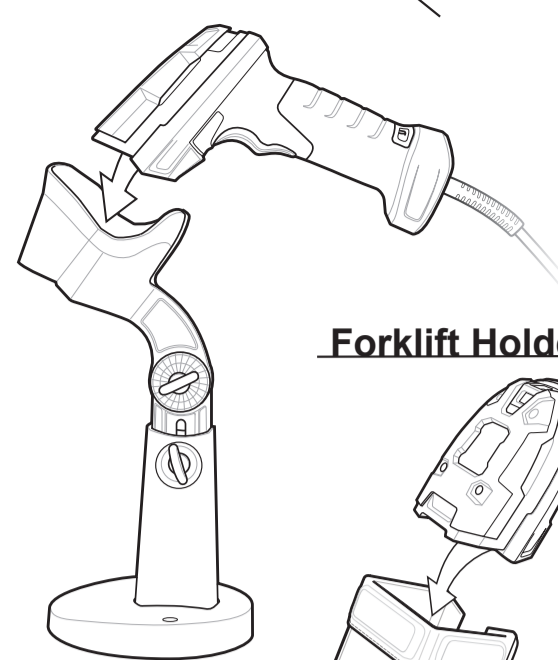

**Forklift Holder**

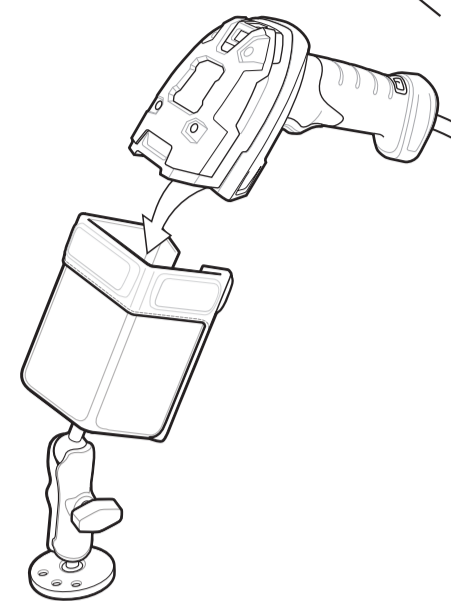

**CABLE ATTACHMENT**

1. Insert cable fully so that the connector is flush with the scanner surface.
2. Loosen metal lock plate screws using a PH1 driver.
3. Slide lock plate to fully locked position.
4. Tighten screw using a PH1 driver (torque: 5 in-lb).

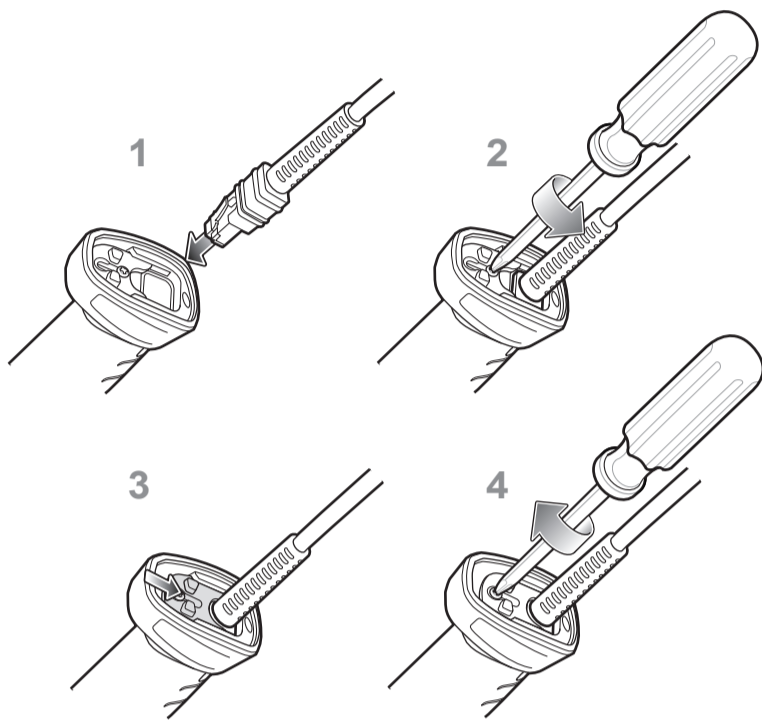

**SET DEFAULTS / ENTER KEY BAR CODES**



RETURN TO FACTORY DEFAULTS

**ADD AN ENTER KEY (Carriage Return/Line Feed)**

To add an Enter key after scanned data, scan the bar code below.

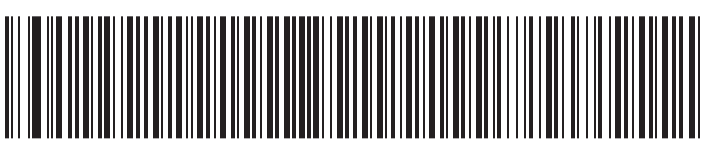

ADD AN ENTER KEY (CARRIAGE RETURN/LINE FEED)

**ADD A TAB KEY**

To add a Tab key after scanned data, scan the bar code below.

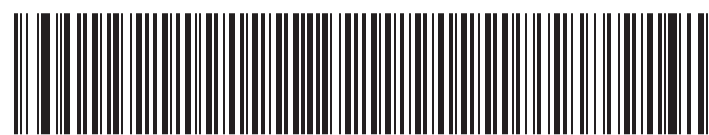

ADD A TAB KEY

**USB CAPS LOCK OVERRIDE BAR CODE**



USB - OVERRIDE CAPS LOCK KEY (ENABLE)



\*USB - DO NOT OVERRIDE CAPS LOCK KEY (DISABLE)

**STEP 1 - CONNECT HOST INTERFACE**

**USB**

NOTE: Cables may vary depending on configuration

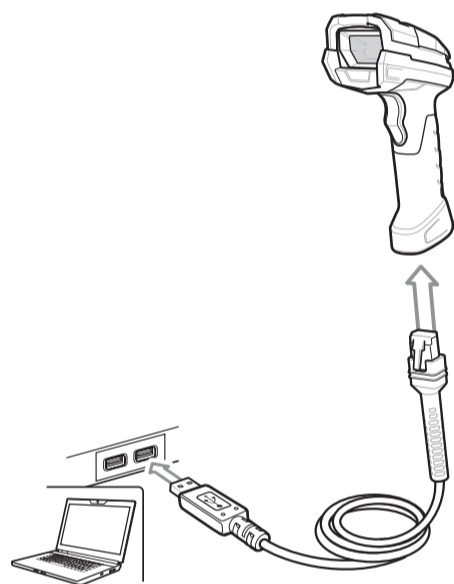

**STEP 2 - SET UP INTERFACE (Scan Host Bar Codes)**

**USB**

Scan **ONE** of the bar codes below

The interface cable automatically detects the host interface type and uses the default setting. If the default (\*) does not meet your requirements, scan another host bar code below.



\*USB KEYBOARD (HID)



USB CDC Host



USB OPOS HAND- HELD



IBM TABLE TOP USB



SNAPI WITHOUT IMAGING



SNAPI WITH IMAGING



SIMPLE COM PORT EMULATION



IBM HAND-HELD USB



SSI OVER USB CDC

**RS-232**

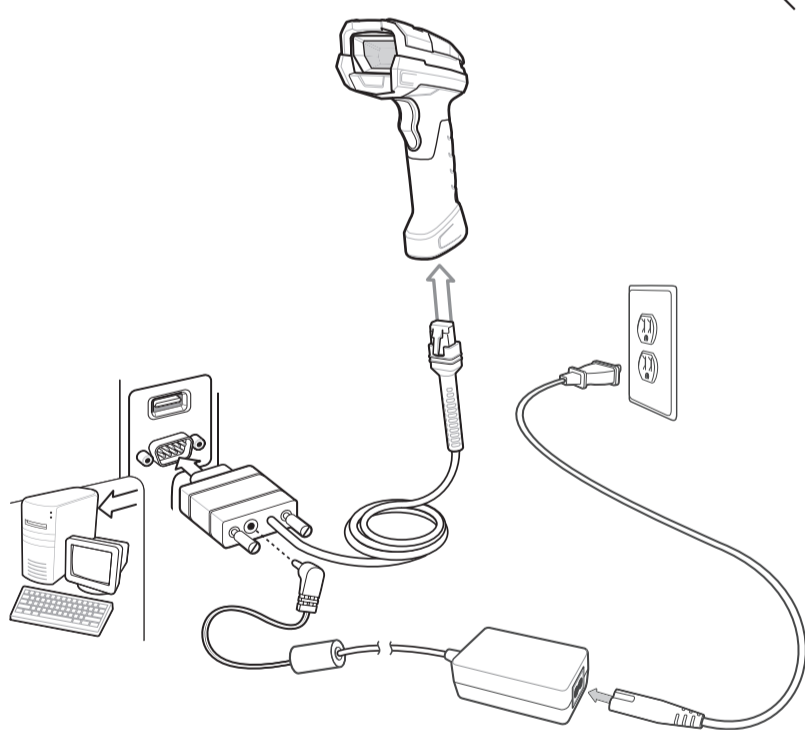

**RS-232**

Scan **ONE** of the bar codes below

The interface cable automatically detects the host interface type and uses the default setting. If the default (\*) does not meet your requirements, scan another host bar code below.



\*STANDARD RS-232



NIXDORF RS-232 MODE B



ICL RS-232



FUJITSU RS-232



NIXDORF RS-232 MODE A



OPOS/JPOS

**Keyboard Wedge**

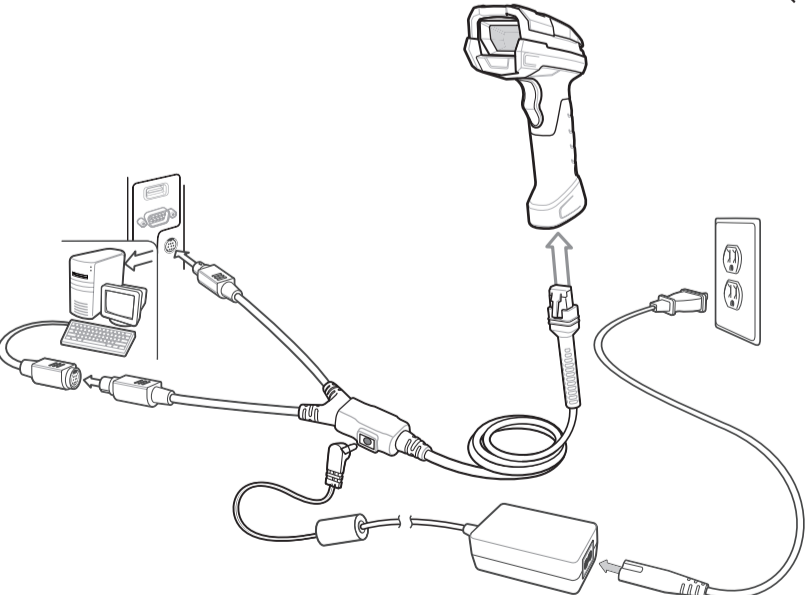

**Keyboard Wedge**

Scan a bar code below

The Auto-Host Detect Cable feature automatically detects the host interface type and uses the default setting. If the default (\*) does not meet your requirements, scan the IBM PC/AT and IBM PC COMPATIBLE bar code below.



\*IBM AT NOTEBOOK



IBM PC/AT and IBM PC COMPATIBLE

**IBM 46XX**

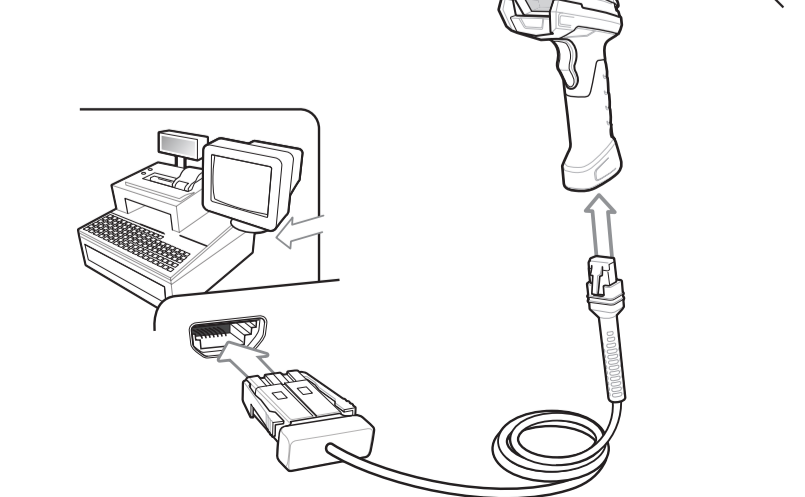

**IBM 46XX**

Scan **ONE** of the bar codes below

The Auto-Host Detect Cable feature automatically detects the host interface type, but there is no default setting. Scan one of the bar codes below to select the appropriate port.



NON-IBM SCANNER EMULATION (PORT 5B)



TABLE-TOP SCANNER EMULATION (PORT 17)



HAND-HELD SCANNER EMULATION (PORT 9B)

# DS3608 DIGITAL SCANNER

## SCANNING

POST IN WORK AREA

### DS3608 - HP/HD Aiming



Cover the entire bar code with the aiming pattern to ensure it is within the field of view.

### DS3608 - SR Aiming



For best results, aim the aiming dot at the center of the bar code.

### DS3608 - ER Aiming



Cover the entire bar code with the aiming pattern to ensure it is within the field of view.

### DS3608 - DP Aiming



For best results, aim the aiming dot at the center of the bar code.

## RECOMMENDED USAGE GUIDE - OPTIMUM BODY POSTURE

### Avoid Extreme Wrist Angles

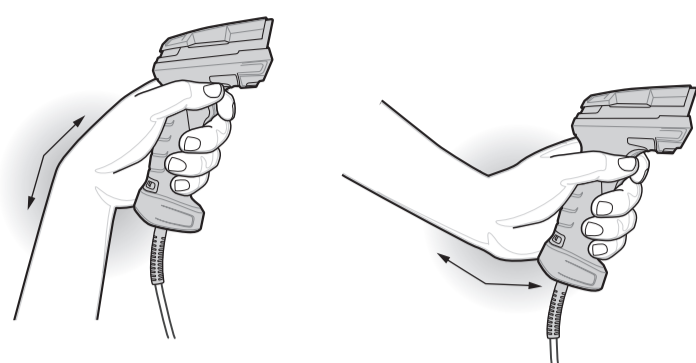

### Avoid Bending



### Avoid Reaching



## BEEPER INDICATIONS

Indication	Beeper Sequence
Power up	Low/medium/high beep
Bar code decoded	Medium beep
Transmission error detected; data is ignored	4 long low beeps
Successful parameter setting	High/low/high/low beep
Correct programming sequence performed	High/low beep
Incorrect programming sequence, or <b>Cancel</b> bar code scanned	Low/high beep

## LED INDICATIONS

Hand-Held Scanning	
Indication	LED Indicator
Scanner is on and ready to scan, or no power to scanner	Off
Bar code is successfully decoded	Green
Transmission error	Red
Hands-Free (Presentation) Scanning	
No power to scanner	Off
Scanner is ready to scan	Green
Bar code is successfully decoded	Off Momentarily
Transmission error	Red

Local Contact: \_\_\_\_\_

## TROUBLESHOOTING

Scanner not working	
No power to scanner	Check system power.
Scanner is disabled	Ensure that correct host interface cable is used.
Scanner decoding bar code, but data not transmitting to host	
Host interface not configured properly	Scan appropriate host parameter bar codes.
Interface cable is loose	Ensure all cable connections are secure.
Invalid ADF Rule	Program the correct ADF rules.

Scanner not decoding bar code	
Scanner not programmed for bar code type	Ensure scanner is programmed to read type of bar code scanned.
Bar code unreadable	Ensure bar code is not defaced; try scanning test bar code of same bar code type.
Distance between scanner and bar code incorrect	Move scanner closer to, or further from bar code.
Scanned data incorrectly displayed on host	
Host interface not configured properly	Scan appropriate host parameter bar codes.
Region improperly configured	Select appropriate country and language encoding scheme.

## REGULATORY INFORMATION

© 2015 Zebra Technologies, Inc.  
 Zebra reserves the right to make changes to any product to improve reliability, function, or design. Zebra does not assume any product liability arising out of, or in connection with, the application or use of any product, circuit, or application described herein. No license is granted, either expressly or by implication, estoppel, or otherwise under any patent right or patent, covering or relating to any combination, system, apparatus, machine, material, method, or process in which Zebra products might be used. An implied license exists only for equipment, circuits, and subsystems contained in Zebra products.

**Warranty**  
 For the complete Zebra hardware product warranty statement, go to: <http://www.zebra.com/warranty>.

**For Australia Only.**  
 This warranty is given by Zebra Technologies Asia Pacific Pte. Ltd., 71 Robinson Road, #05-02/03, Singapore 068895, Singapore. Our goods come with guarantees that cannot be excluded under the Australian Consumer Law. You are entitled to a replacement or refund for a major failure and compensation for any other reasonably foreseeable loss or damage. You are also entitled to have the goods repaired or replaced if the goods fail to be of acceptable quality and the failure does not amount to a major failure. Zebra Technologies Corporation Australia's limited warranty above is in addition to any rights and remedies you may have under the Australian Consumer Law. If you have any queries, please call Zebra Technologies Corporation at +65 6858 0722. You may also visit our website: <http://www.zebra.com> for the most updated warranty terms.

**Service Information**  
 If you have a problem using the equipment, contact your facility's Technical or Systems Support. If there is a problem with the equipment, they will contact the Zebra Global Customer Support Center at: <http://www.zebra.com/support>.  
 For the latest version of this guide go to: <http://www.zebra.com/support>.

### Waste Electrical and Electronic Equipment (WEEE)

English: For EU Customers: All products at the end of their life must be returned to Zebra for recycling. For information on how to return product, please go to: <http://www.zebra.com/weee>.  
 Bulgarian: За клиентите от ЕС: След края на ползването им живот всички продукти трябва да се връщат на Zebra за рециклиране. За информация относно връщането на продукти, моля отидете на адрес: <http://www.zebra.com/weee>.  
 Čeština: Pro zákazníky z EU: Všechny produkty je nutné po skončení jejich životnosti vrátit společnosti Zebra k recyklaci. Informace o způsobu vrácení produktu najdete na webové stránce: <http://www.zebra.com/weee>.  
 Dansk: Til kunder i EU: Alle produkter skal returneres til Zebra til recirkulering, når de er udtjent. Læs oplysningerne om returnering af produkter på: <http://www.zebra.com/weee>.  
 Deutsch: Für Kunden innerhalb der EU: Alle Produkte müssen am Ende ihrer Lebensdauer zum Recycling an Zebra zurückgegeben werden. Informationen zur Rücksendung von Produkten finden Sie unter <http://www.zebra.com/weee>.  
 Ελληνικά: Για πελάτες στην Ε.Ε.: Όλα τα προϊόντα, στο τέλος της διάρκειας ζωής τους, πρέπει να επιστρέφονται στην Zebra για ανακύκλωση. Για περισσότερές πληροφορίες σχετικά με την επιστροφή ενός προϊόντος, επισκεφθείτε τη διεύθυνση <http://www.zebra.com/weee> στο Διαδίκτυο.  
 Eesti: EL klientidele: kõik tooted tuleb nende elusa lõppedes tagastada taaskasutamise eesmärgil Zebra'le. Lisainformatsiooni saamiseks toote tagastamise kohta külastage palun aadressi: <http://www.zebra.com/weee>.  
 Español: Para clientes en la Unión Europea: todos los productos deberán entregarse a Zebra al final de su ciclo de vida para que sean reciclados. Si desea más información sobre cómo devolver un producto, visite: <http://www.zebra.com/weee>.  
 Français: Clients de l'Union Européenne : Tous les produits en fin de cycle de vie doivent être retournés à Zebra pour recyclage. Pour de plus amples informations sur le retour de produits, consultez : <http://www.zebra.com/weee>.  
 Italiano: per i clienti dell'UE: tutti i prodotti che sono giunti al termine del rispettivo ciclo di vita devono essere restituiti a Zebra al fine di consentirne il riciclaggio. Per informazioni sulle modalità di restituzione, visitate il seguente sito Web: <http://www.zebra.com/weee>.  
 Latvīšu: ES klientiem: visi produkti pēc to kalpošanas mūža beigām ir jānogādā atpakaļ Zebra atzīstībai pārstrādei. Lai iegūtu informāciju par produktu nogādāšanu Zebra, lūdz, skatīt: <http://www.zebra.com/weee>.  
 Lietuvių: ES vartotojams: visi gaminiai, pasibaigus jų eksploatacijos laikui, turi būti gražinti utilizuoti į kompaniją „Zebra“. Daugiau informacijos, kaip gražinti gaminį, rasite: <http://www.zebra.com/weee>.  
 Magyar: Az EU-ban vásárlóknak: Minden tönkremennterméket a Zebra vállalatához kell eljuttatni újrahasznosítás céljából. A termék visszajuttatásának módjával kapcsolatos tudnivalóért látogasson el a <http://www.zebra.com/weee> weboldalra.  
 Malti: Għal klijenti fl-UE: il-prodotti kollha li jkun u waslu fl-aħħar ta' l-użu tagħhom, iridu jiġu ritornati għand Zebra għar-riċiklaġġ. Għal aktar taġġir dwar kif għandek tirritorna l-prodott, jekk jogħġbok żur: <http://www.zebra.com/weee>.  
 Nederlands: Voor klanten in de EU: alle producten dienen aan het einde van hun levensduur naar Zebra te worden teruggezonden voor recycling. Raadpleeg <http://www.zebra.com/weee> voor meer informatie over het terugzenden van producten.  
 Polski: Klienci z obszaru Unii Europejskiej: Produkty wycofane z eksploatacji należy zwrócić do firmy Zebra w celu ich utylizacji. Informacje na temat zwrotu produktów znajdują się na stronie internetowej <http://www.zebra.com/weee>.  
 Português: Para clientes da UE: todos os produtos no fim de vida devem ser devolvidos à Zebra para reciclagem. Para obter informações sobre como devolver o produto, visite: <http://www.zebra.com/weee>.  
 Românește: Pentru clienții din UE: Toate produsele la sfârșitul duratei lor de funcționare, trebuie returnate la Zebra pentru reciclare. Pentru informații despre returnarea produsului, accesați: <http://www.zebra.com/weee>.  
 Slovenčina: Pre zákazníkov z krajín EU: Všetky výrobky musia byť po uplynutí doby ich životnosti vrátené spoločnosti Zebra na recykláciu. Blížšie informácie o vrátení výrobkov nájdete na: <http://www.zebra.com/weee>.  
 Slovenski: Za kupce v EU: vsi izdelki se morajo po poteku življenjske dobe vrniti podjetju Zebra za reciklazo. Za informacije o vračilu izdelka obiščite: <http://www.zebra.com/weee>.  
 Suomi: Asiakkaita Euroopan unionin alueella: Kaikki tuotteet on palautettava kierrätettäväksi Zebra-yhtiöön, kun tuotetta ei enää käytetä. Lisätietoja tuotteiden palauttamisesta on osoitteessa <http://www.zebra.com/weee>.  
 Svenska: För kunder inom EU: Alla produkter som uppnått sin livslängd måste returneras till Zebra för återvinning. Information om hur du returnerar produkten finns på <http://www.zebra.com/weee>.  
 Türkçe: AB Müşterileri için: Kullanım süresi dolan tüm ürünler geri dönüşümüne için Zebra'ya iade edilmelidir. Ürünlerin nasıl iade edileceği hakkında bilgi için lütfen şu adresi ziyaret edin: <http://www.zebra.com/weee>.

TURKISH WEEE Statement of Compliance  
 EEE Yönetmeliğine Uygundur

### Regulatory Information

This device is approved under Zebra Technologies Corporation.

This guide applies to Model Number: DS3608. All Zebra devices are designed to be compliant with rules and regulations in locations they are sold and will be labeled as required. Local language translations are available at the following website: <http://www.zebra.com/support>

Any changes or modifications to Zebra equipment, not expressly approved by Zebra, could void the user's authority to operate the equipment.

### Health and Safety Recommendation

#### Ergonomic Recommendations

**Caution:** In order to avoid or minimize the potential risk of ergonomic injury follow the recommendations below. Consult with your local Health & Safety Manager to ensure that you are adhering to your company's safety programs to prevent employee injury.

- Reduce or eliminate repetitive motion
- Maintain a natural position
- Reduce or eliminate excessive force
- Keep objects that are used frequently within easy reach
- Perform tasks at correct heights
- Reduce or eliminate vibration
- Reduce or eliminate direct pressure
- Provide adjustable workstations
- Provide adequate clearance
- Provide a suitable working environment
- Improve work procedures.

LED Compliance Statement:  
 Classified as "EXEMPT RISK GROUP" according to IEC 62471:2006 and EN 62471:2008.  
 Pulse Duration: Continuous

### Laser Devices

Class 2 laser scanners use a low power, visible light diode. As with any very bright light source, such as the sun, the user should avoid staring directly into the light beam. Momentary exposure to a Class 2 laser is not known to be harmful.



The following statement is required to comply with US and international regulations.  
**Caution:** Use of controls or adjustments or performance of procedures other than those specified herein may result in hazardous laser light exposure.  
 Laser and LED light is emitted from this aperture:

DS3608-SR - LED Exempt Risk Group
DS3608-ER - Class 2
DS3608-HP - Class 2
DS3608-HD - Class 2
DS3608-DP - Class 2

LASER LIGHT - DO NOT STARE INTO BEAM.  
 CLASS 2 LASER PRODUCT.  
 DS3608-SR - Label not applicable.  
 DS3608-DP - Label located on side of scanner.

Complies with 21CFR1040.10 & 1040.11 except for deviations pursuant to Laser Notice NO. 50, dated June 24, 2007 and IEC/EN 60825-1:2007 and/or IEC/EN 60825-1:2014

### Power Supply

Use ONLY a Zebra approved UL LISTED ITE (IEC/EN 60950-1, LPS/SELV) power supply with electrical ratings: Output 5 Vdc, min 0.2A, with a maximum ambient temperature of a least 50 degrees C. Use of alternative power supply will invalidate any approvals given to this unit and may be dangerous.

Note: The optional external power supply, P/N: PWRS-14000-148R is rated for use in a 40 degrees C maximum ambient temperature.

### Radio Frequency Interference Requirements - FCC



Note: This equipment has been tested and found to comply with the limits for a Class B digital device, pursuant to Part 15 of the FCC rules. These limits are designed to provide reasonable protection against harmful interference in a residential installation. This equipment generates, uses and can radiate radio frequency energy and, if not installed and used in accordance with the instructions, may cause harmful interference to radio communications. However there is no guarantee that interference will not occur in a particular installation. If this equipment does cause harmful interference to radio or television reception, which can be determined by turning the equipment off and on, the user is encouraged to try to correct the interference by one or more of the following measures:

- Reorient or relocate the receiving antenna
- Increase the separation between the equipment and receiver
- Connect the equipment into an outlet on a circuit different from that to which the receiver is connected
- Consult the dealer or an experienced radio/TV technician for help.

### Radio Frequency Interference Requirements - Canada

CAN ICES-3 (B)/NMB-3(B).

### CE Marking and European Economic Area (EEA)

### Statement of Compliance

Zebra hereby declares that this device is in compliance with all applicable Directives, 2014/30/EU, 2014/35/EU and 2011/65/EU. The full text of the EU Declaration of Conformity is available at the following internet address: <http://www.zebra.com/doc>.

### Other Countries

#### Japan (VCCI) - Voluntary Control Council for Interference

Class B ITE

この装置は、情報処理装置等電波障害自主規制協議会（VCCI）の基準に基づくクラスB情報技術装置です。この装置は、家庭環境で使用することを目的としていますが、この装置がラジオやテレビジョン受信機に近接して使用されると、受信障害を引き起こすことがあります。取扱説明書に従って正しい取り扱いをして下さい。

#### Korea Warning Statement for Class B ITE

기종 별	사용 자 한 내 문
B급 기기 (가정용 방송통신기기)	이 기기는 가정용(B급)으로 전자파적합등록을 한 기기로서 주로 가정에서 사용하는 것을 목적으로 하며, 모든 지역에서 사용할 수 있습니다.

### Chile

Este equipo cumple con la Resolución No 403 de 2008, de la Subsecretaría de telecomunicaciones, retransmisor de radiaciones electromagnéticas.

### China

通过访问以下网址可下载当地语言支持的产品说明书 [www.zebra.com/contact](http://www.zebra.com/contact)



### Thailand

เครื่องใช้ในบ้านและอุปกรณ์ มีความสอดคล้องกับข้อกำหนดของ กทช.

### Ukraine

Дане обладнання відповідає вимогам технічного регламенту №1057, № 2008 на обмеження щодо використання деяких небезпечних речовин в електричних та електронних пристроях.

### China RoHS

This table was created to comply with China RoHS requirements.

部件名称 (Parts)	有害物质					
	铅 (Pb)	汞 (Hg)	镉 (Cd)	六价铬 (Cr (VI))	多溴联苯 (PBB)	多溴二苯醚 (PBDE)
金属部件 (Metal Parts)	X	0	0	0	0	0
电路模块 (Circuit Modules)	X	0	0	0	0	0
电缆及电缆组件 (Cables and Cable Assemblies)	0	0	0	0	0	0
塑料和聚合物部件 (Plastic and Polymeric Parts)	0	0	0	0	0	0
光学和光学组件 (Optics and Optical Components)	X	0	0	0	0	0
电池 (Batteries)	0	0	0	0	0	0

本表格依据SJ/T 11364 的规定编制。

0: 表示该有害物质在该部件所有均质材料中的含量均在 SJ/T 11364—2014 规定的限量要求以下。  
 X: 表示该有害物质至少在该部件的某一均质材料中的含量超出 SJ/T 11364—2014 规定的限量要求。(企业可在此处, 根据实际情况对上表中打“X”的技术原因进行进一步说明。)

This table was created to comply with China RoHS requirements.

123Scan<sup>2</sup> is an easy-to-use, PC-based software tool that enables rapid and easy customized setup of a scanner via a bar code or USB cable.

For more information, visit: <http://www.zebra.com/123Scan>.



Zebra Technologies Corporation  
 3 Overlook Point  
 Lincolnshire, IL U.S.A.  
<http://www.zebra.com>

Zebra and the stylized Zebra head are trademarks of ZIH Corp., registered in many jurisdictions worldwide. All other trademarks are the property of their respective owners.

© 2016 Symbol Technologies LLC, a subsidiary of Zebra Technologies Corporation. All rights reserved.



MN002257A01 Revision C - June 2016

# DS3608 DIGITAL SCANNER

## UTILITY FUNCTIONALITY

- Device Configuration
- Electronic Programming (USB Cable)
- Programming Bar Code(s)
- Data View – Scan Log (Display Scanned Bar Code Data)

- Access Asset Tracking Information
- Upgrade Firmware and View Release Notes
- Remote Management (SMS Package Generation)